



GARAGE DOOR OPENER EXTENSION KIT

MODEL: 425-1671

⚠️ WARNING





To prevent **SERIOUS INJURY** or **DEATH**:



- DO NOT connect power until instructed.
- CLOSE the door before installation.



www.gdohelp.com
 1-877-GDO-4402
 1-877-436-4402
 2301 Traffic St NE
 Minneapolis, MN 55413

Kit Inventory

-  x 1
End Segment with Trolley Stop Bolt (53-1/5 inch)
-  x 1
Middle Segment (53-1/5 inch)
-  x 1
Header Segment (53-1/5 inch)
-  x 1
Extended Chain Segment (approx. 40-4/5 inch)

-  x 1
Extended Cable (approx. 144-1/2 inch)
-  x 2
Master Link Set (Including 1x spare set)

Components Required from Opener Inventory

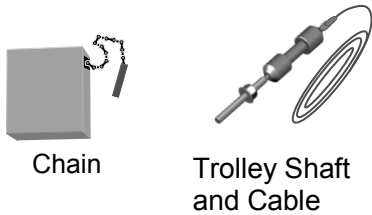





Chain

Trolley Shaft and Cable

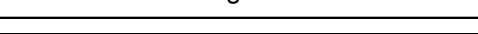

Discard all 5 segments from original opener

-  Rail — Header Segment
-  Rail — End Segment with Trolley Stop Bolt
-  Rail — Middle Segment
-  Rail — Middle Segment
-  Rail — Middle Segment

STEP 1. To Assemble Rail with “Extended Middle Segment”

Please refer to “Rail and Trolley Assembly” in Owner’s Manual.

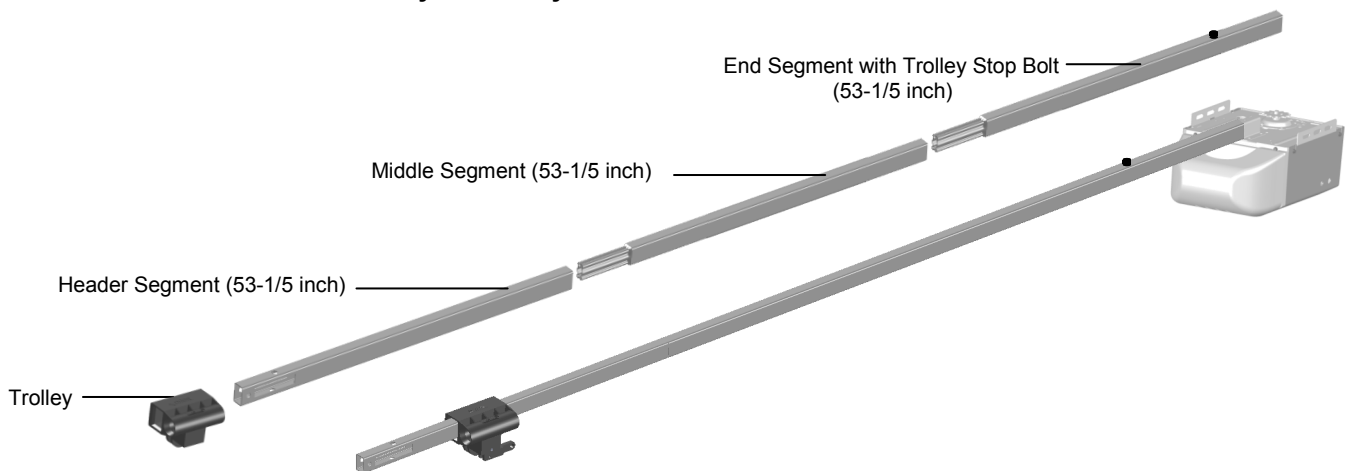

⚠️ WARNING

- Discard all FIVE of the original rail segment.
- ONLY 3 pieces of extended rail segment should be applied. NEVER connect extra rail segments.
- The opener only services door to max. of 10 FT. height. Door, with other size please call service before installation.

Step 2. Extending the Chain

1. To Disconnect "Chain to Cable Connector" from the Original Chain

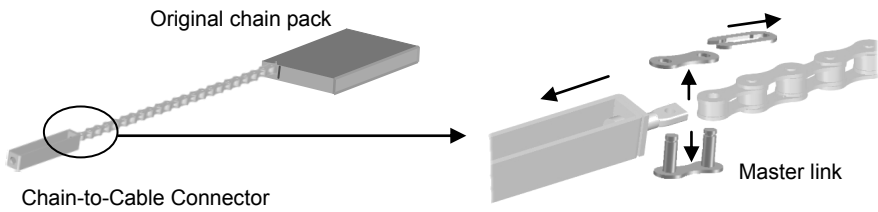

Disconnect the "Chain to Cable Connector" from the original chain by removing the master link.

Keep all the hardware in this step.

2. To Connect "Extended Chain Segment" to Chain

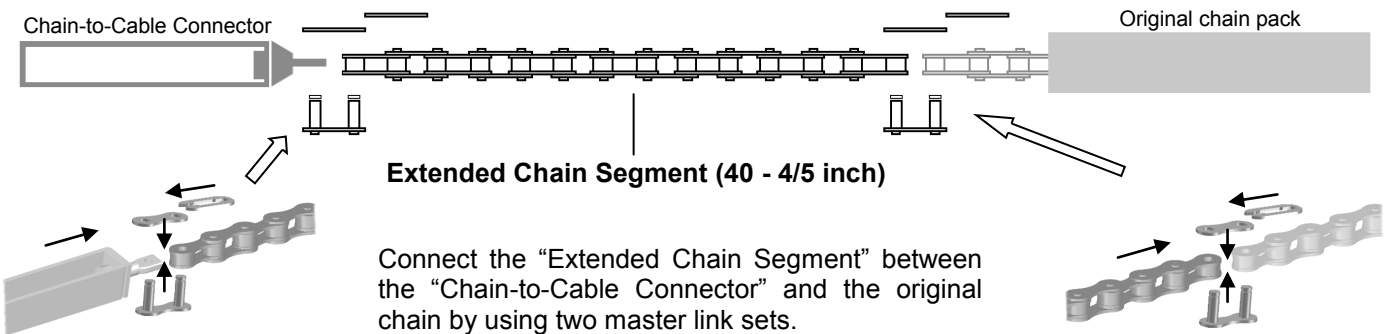

Connect the "Extended Chain Segment" between the "Chain-to-Cable Connector" and the original chain by using two master link sets.

Step 3. Extending the Cable

Replace the original cable with the "Extended Cable"

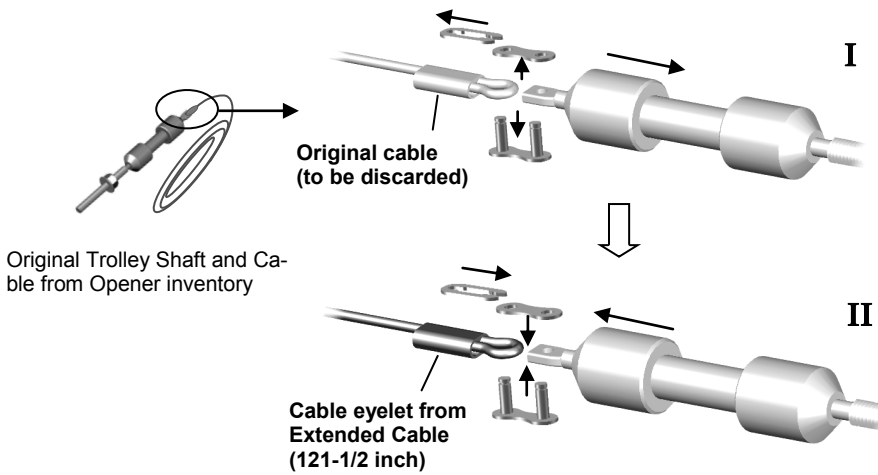

I. Disconnect the "Trolley Shaft" from the original cable by removing the master link.

Discard the original cable.

II. Align the "Trolley Shaft" to one of the eyelets of the "Extended Cable", connect them together using the master link set.

Step 4. Proceeding with Installation of Opener

The Rail Assembly Extension has now been finished.

The Rail Assembly consists of 3 pieces of extended rail segments, chain segment and cable with eyelets.

ALL 5 pieces of original rail segment and original cable are discarded.

Please proceed installation of opener starting with "Rail and Trolley Assembly" in Owner's Manual.